

Components

Category : [John D. Steele's Sons Limited](#)

Published by admin on 08-Feb-2014 20:29



emp 13



emp

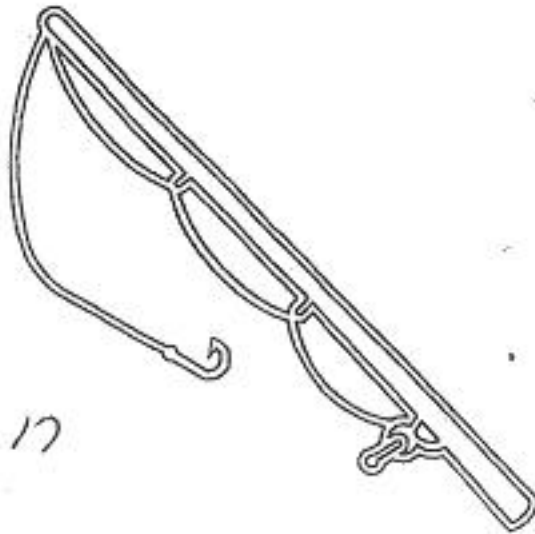

emp 17



emp

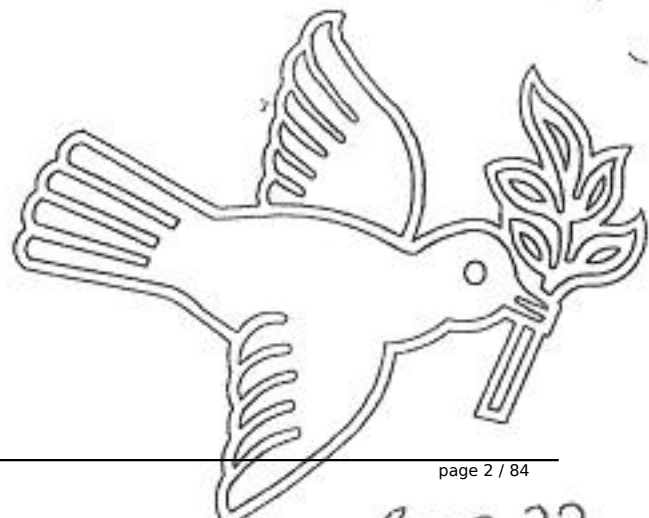

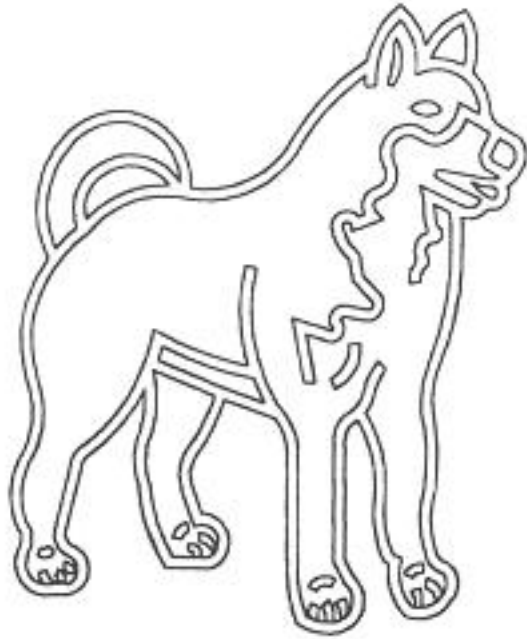

Emp 25



em



Emp 29

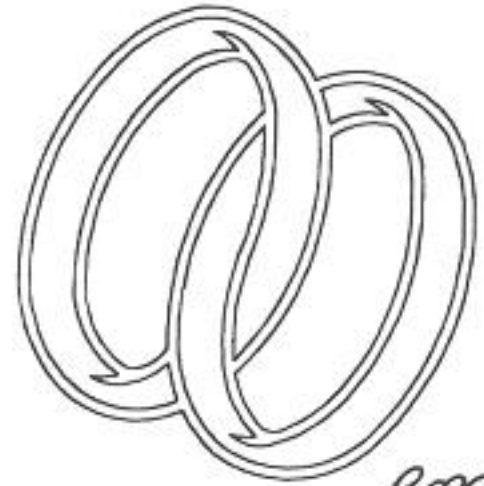

Emp

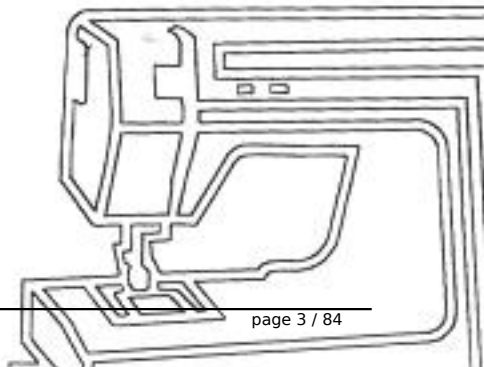
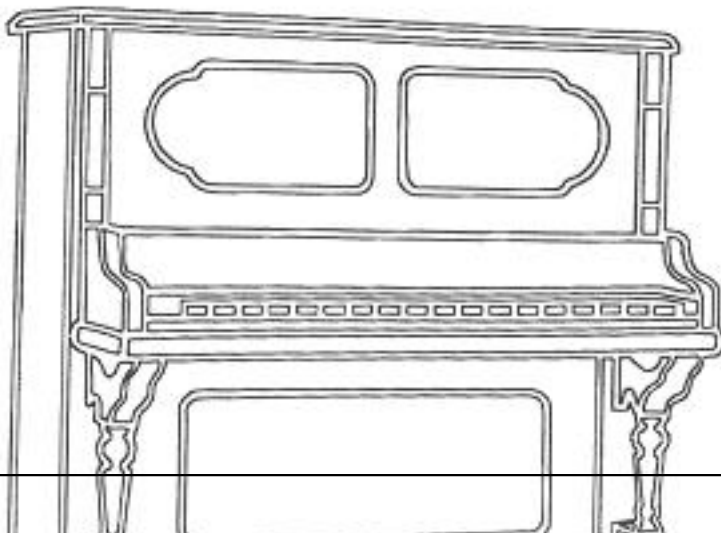



emp 37



emp 38

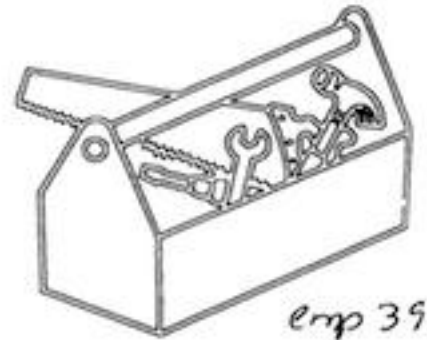

emp 39



emp 41



emp 42



emp 43



emp 44



emp 45



emp 46



emp 48



emp 49



emp 50



emp 52



emp 53



emp 54



emp 56



emp 57



emp 58

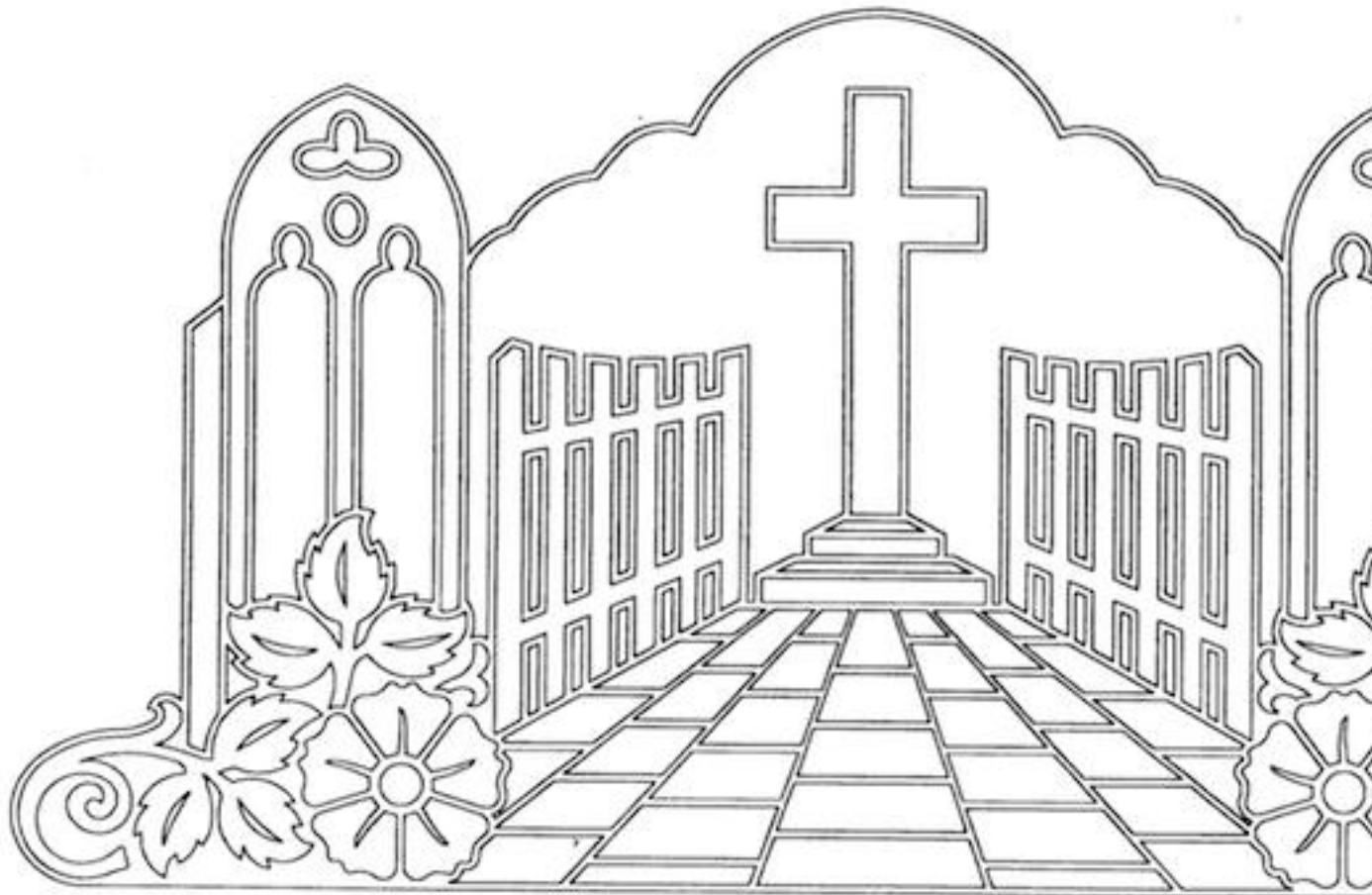

e

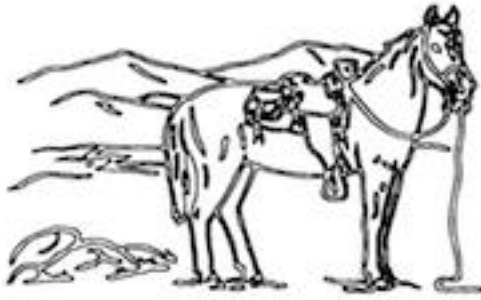

Emp 61



Emp 62



Emp 63



Emp 65



Emp 66



Emp 67



Emp 69

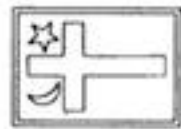

Emp 70



Emp 71



emp 73

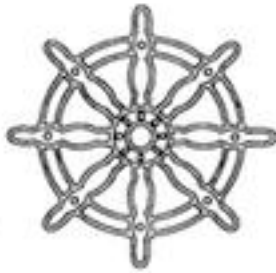

emp 74

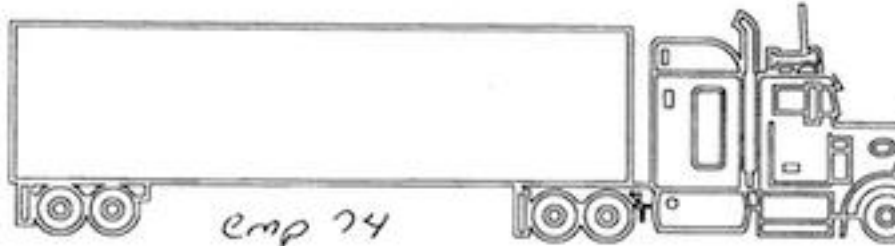

emp 76

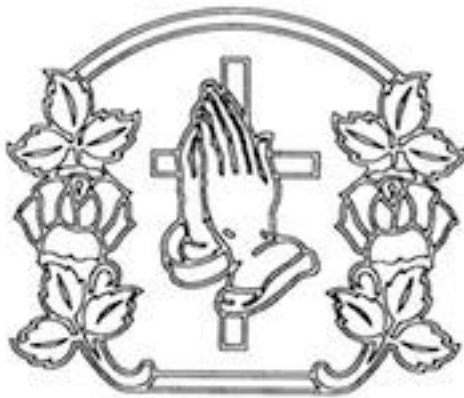

emp 77



emp 78



emp 80



emp 81



emp 82





emp 84



emp 85



emp 86



emp 88



emp 89



emp 91



emp 92



emp 93

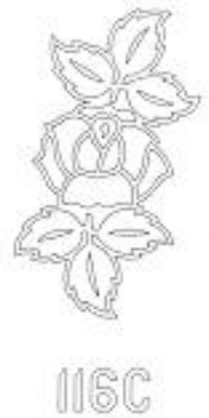
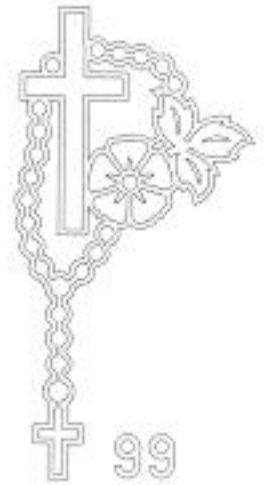
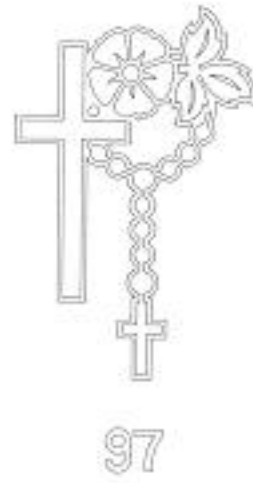
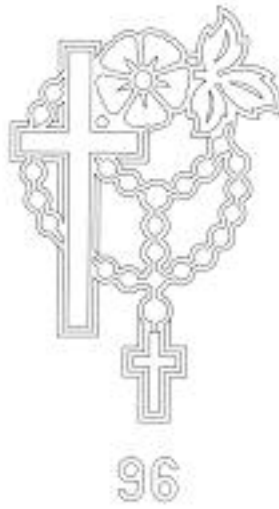









emp 138



emp 139



emp 140



emp 142



emp 143



emp 145



Cmp 159



Cmp 160



Cmp 161



Cmp 163



Cmp 164

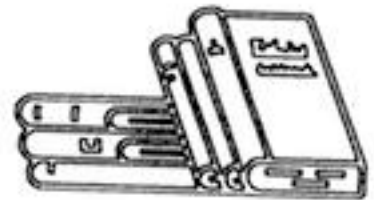

Cmp 165



Cmp 167



Cmp 168



Cmp 170



Emp 169



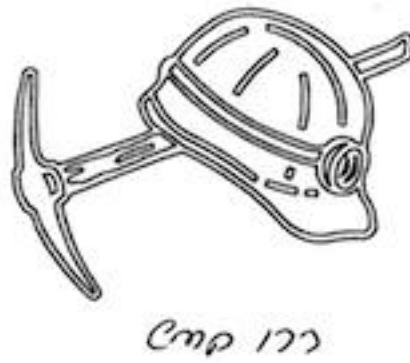
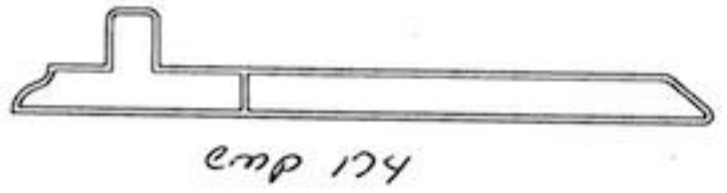
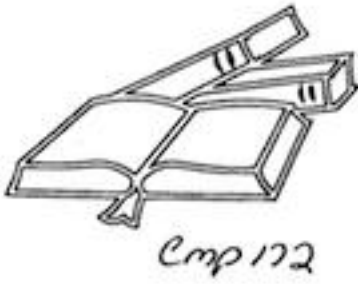



Cmp 186

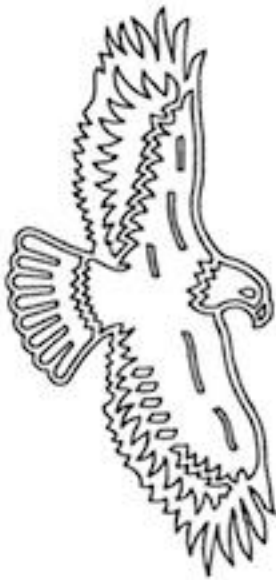

Cmp 191

Cmp 187

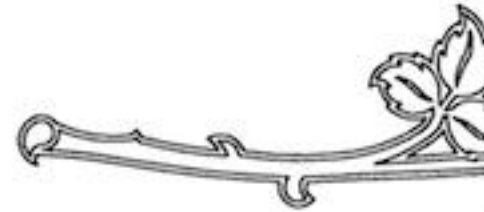
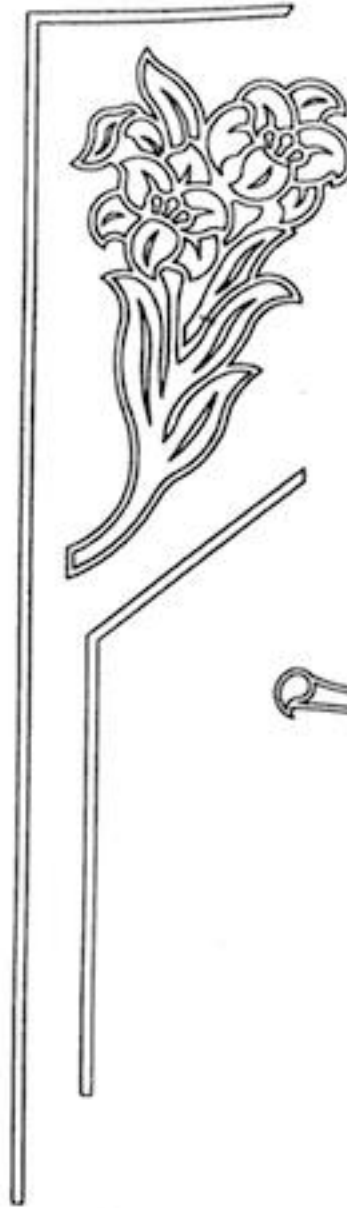

Cmp 188



Cmp 192



Cmp 193



Cmp 194

Cmp 196



Cmp 197

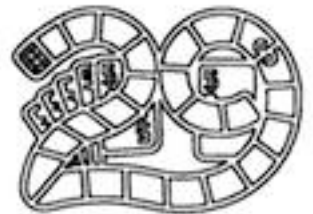

Cmp 198



Cmp 200



Cmp 201



Cmp 202



Cmp 205

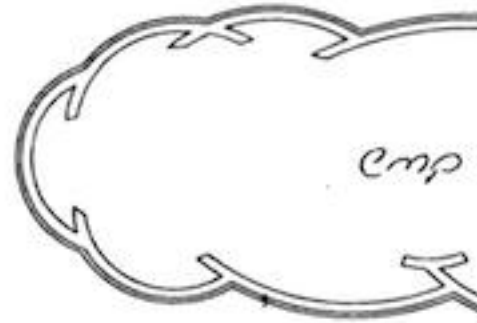

Cmp



Cmp 204



Cmp 207



Cmp 208

B	I	N	G	O
8	21	32	55	71
11	25	41	47	62
10	18		53	61
3	17	37	51	72
2	23	31	56	63

Cmp 209



Cmp 210



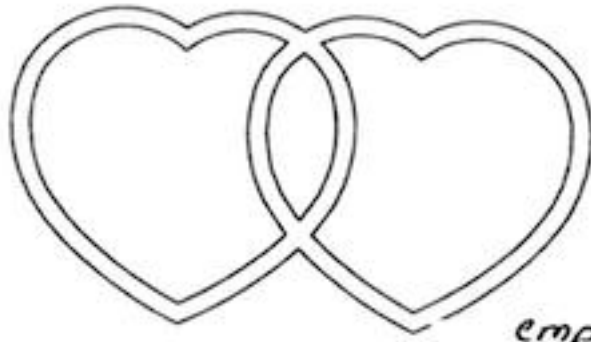

emp 221

*Together
Forever*

emp 222

Father

emp 223

Mother

emp 224





Cmp 229



Cmp 230



Cmp 231



Cmp 232

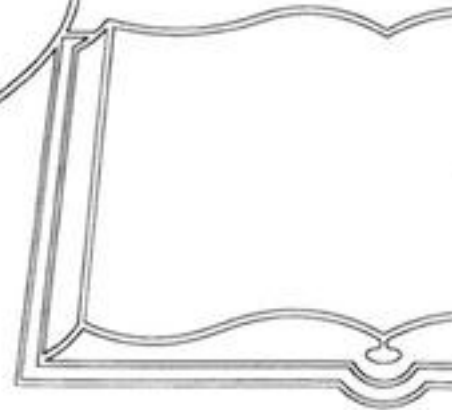
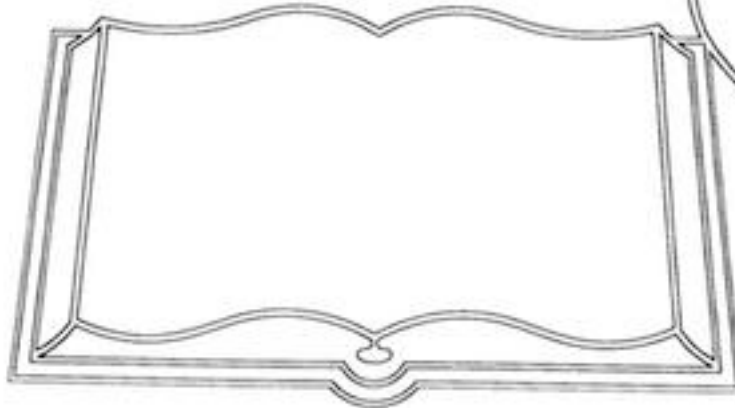



Cmp 235

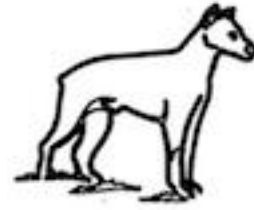

emp 236



emp 238



emp 239



emp 240



emp 242



emp 243

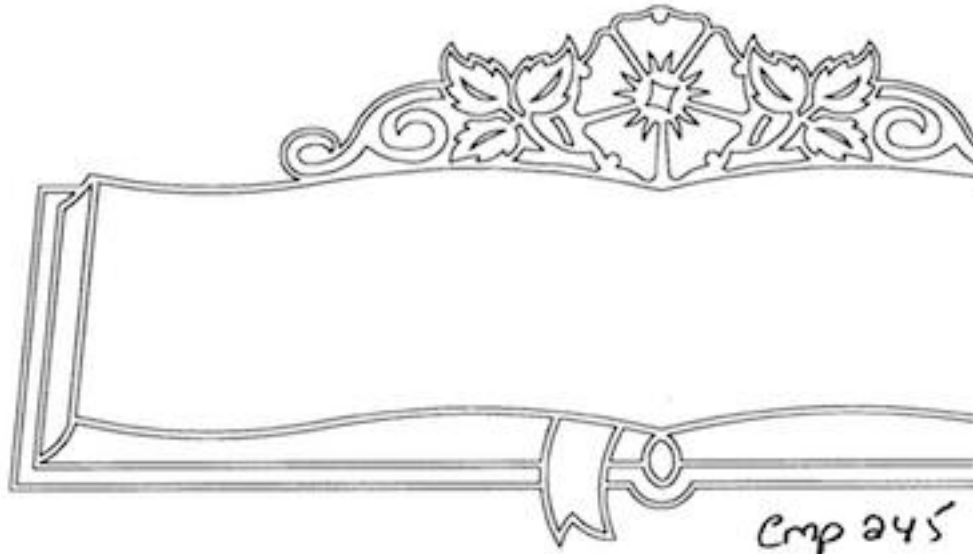

emp 245



emp 246



emp 247



emp 249



emp 250



emp 252



emp 253



emp 255

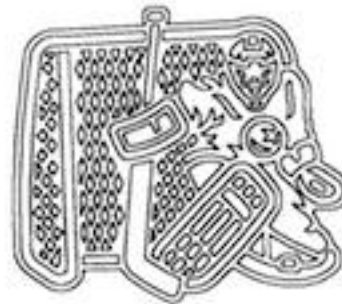

emp 256





cmp 257



cmp 258

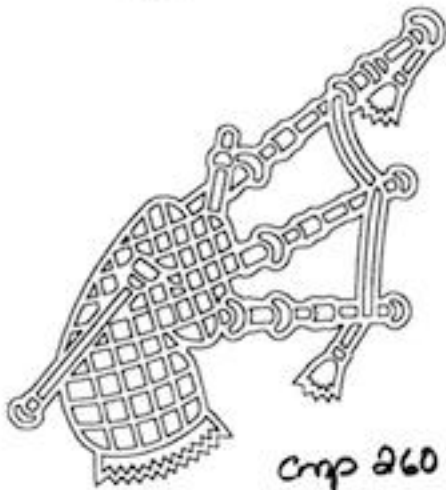

cmp 260



cmp 261

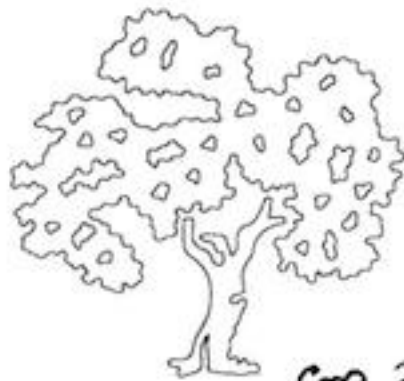

cmp 263



cmp 264



cmp 266



cmp 267



cmp 268



cmp 271



cmp 273



cmp 274

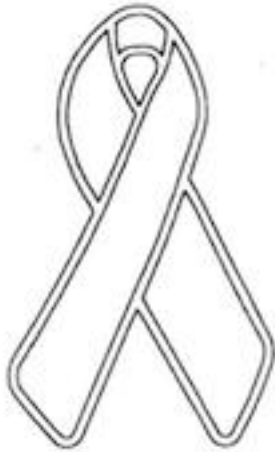

cmp 275



cmp 276



cmp 278



cmp 281



cmp 279



cmp 283



cmp 284

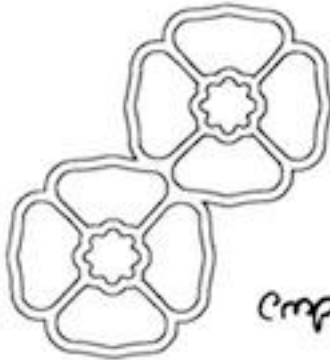

cmp 286

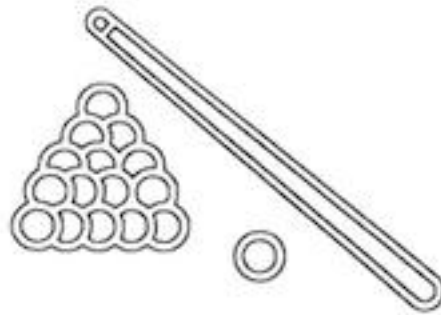

cmp 287

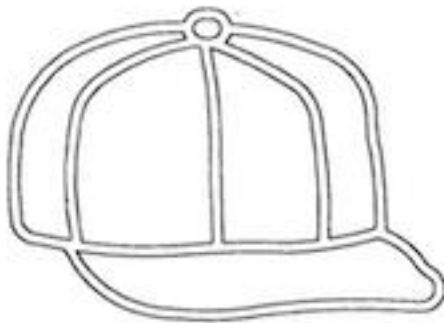

cmp 289



cmp 290

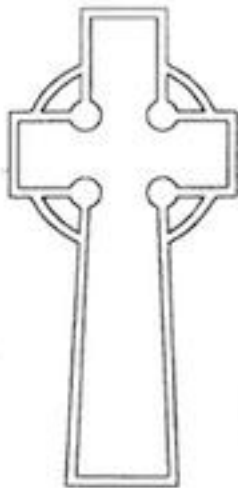

emp 291



emp 292



emp 294



emp 295



emp 297



emp 298



emp 299



emp 300



emp 303



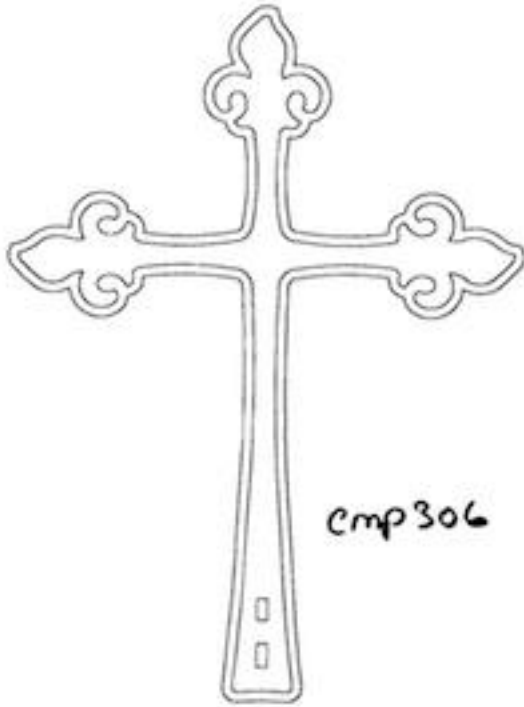

emp 306



emp 307

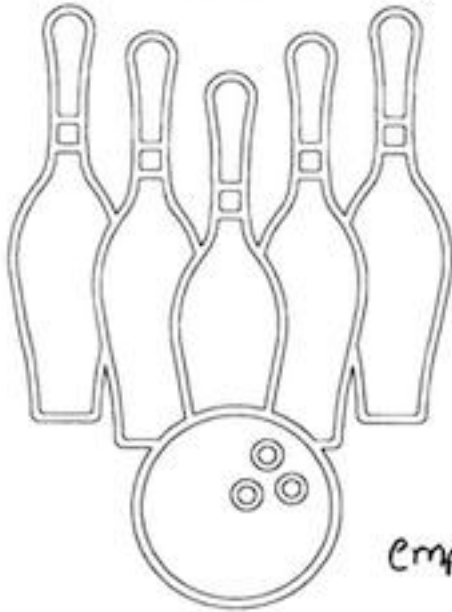

emp 309

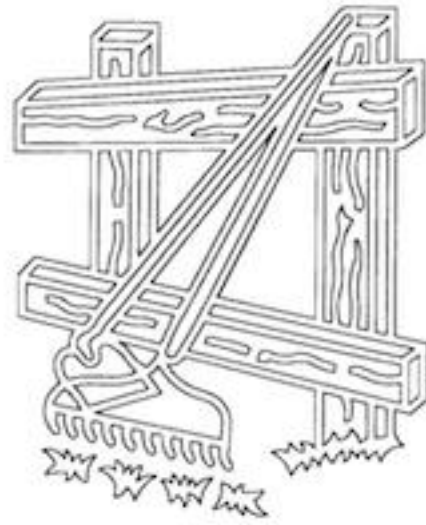

emp 310

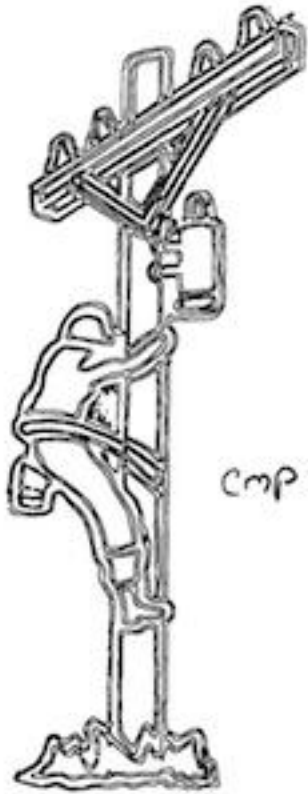

Cmp 312

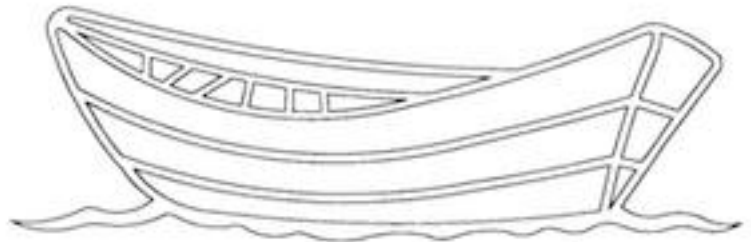

Cmp 313

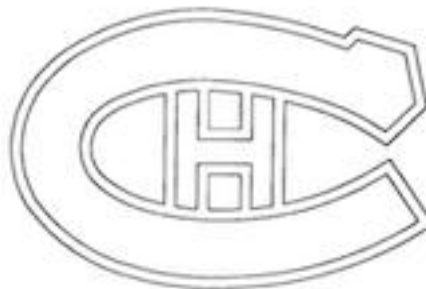

Cmp 315



Cmp 316

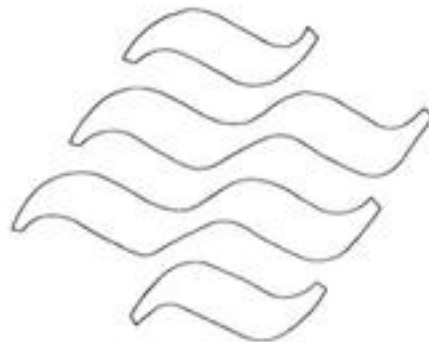

Cmp 317





emp 320



emp 321



emp 323



emp 325



emp 326



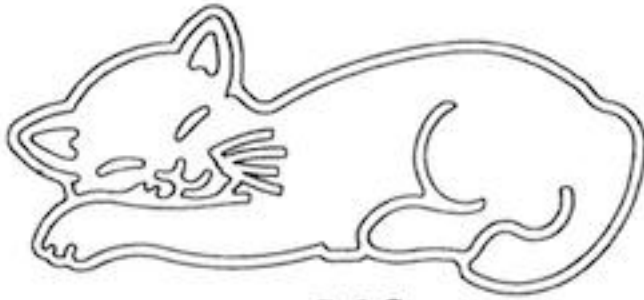

Cmp 328

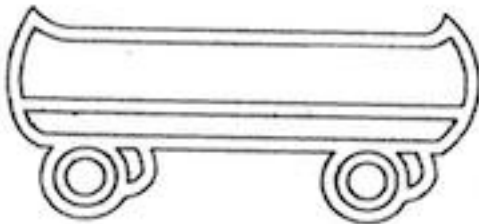
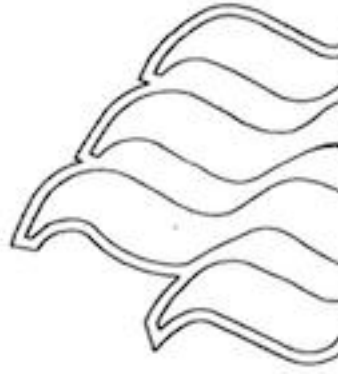

Cmp 330



Cmp 331

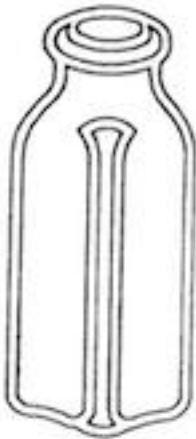

Cmp 333



Cmp 334

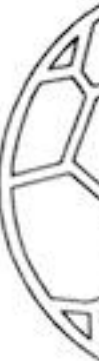

NOTJINEN

**NOTJINEN OASOG EPIN, TJIPTOG TELOISIN
MEGITETWEG; OASOG NTELITANEN TJIPTOG
IGMEMOIEG OLA NEMOLEG OLETESMEN; NATEL
OASOG EIGIG TELI SGATASGIG TJIPTOG ELP NINEN
TELI SGATOLEG NAGANIGEG EWEG.
TELAMOGOPENIGEL ESEMIEGEL APTJ NIGETJ
GISGOG TELAMOGTETJ PENEGOMEMOIN NILOWEN,
TELI APIGSIGTAGATJIG OEGAIONAMETEPENIG ELP
GIL, NISGAM TLI APIGSIGTOIN ELOEOTIEG,
WELGENIN NETJ OINSOTIL MO
GTIGALINEN; GESINOGOANGEL OINTJIGEL GOGOEL
TJIGELATOIN.
MTLIATJ**

Cmp 336

GOLEIN W

**GOLEIN WALI, SAPEOT
GESAGWAMIRO TEGOEIS
OLEINEG, AG OELEG TAN GTE
SESOS
PETJILI SAPEOIN WALI DE
NIGETJ ALASOTWGLSEOIN EJI
AG APIS OIGOIATIEG ALAS
MTLIAT**

Cmp



Cmp 338



Cmp 339



emp 340



Cmp 342



Cmp 343



Cmp 345

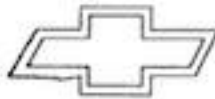

Cmp 346



Cmp 347

Precious Memories

Cmp 349



Cmp 350



Cmp 352



Cmp 353



Cmp 354



Cmp 356



Cmp 357



Cmp 358



Cmp 360



Cmp 361

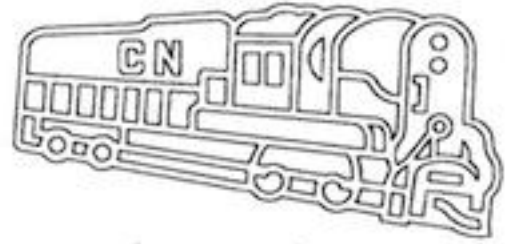

Cmp 362



Cmp 364



Cmp 365



Cmp 366

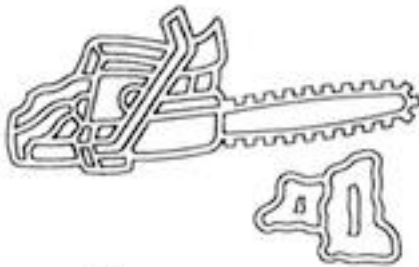

Cmp 368



Cmp 369

Cmp 371



Cmp 372



Cmp 373



Cmp 375



Cmp 376



Cmp 377



Cmp 379



Cmp 380

Cmp 381





Cmp 383



PACKERS

Cmp 384



Cmp 385



Cmp 386

ALASUTMAQNI WJIT SE'T A'N

HEWITE' TE'N HAWI-KLU'SIN HUKUMIJINEN SE'T A'N.
 KI'L TA'N WEJI-WISURIN SAPE'WUTI-IKTUK AQQ
 KETLAMITE'TEKEN. HHA'Q WEN ALU'TAWAQTMAQ
 TA'N ELITA'SUALISK ELASUMULEK APOQIWIEN.
 ELITA'SUALNEK KI'L WELWITU'N AQQ EWLITE'TEKEN.
 HUKUMIJINEN EL-WUTRULPUKUA'SI KXATK, KI'N TA'N
 KUJI-PATAWTU XIXJI-PUXUAS'SI TA'N EYNN,
 TOQO TA'N TELI-KSUXK HTUE'WUTI'L,
 APOQIWI O'HAWI-KLU'SIN HUKUMIJINEN,
 SE'T A'N HXIJINEN WA'LI PEKISULSIP WRSITQAWU'K.
 HUXK ALUSTUIW, JIKSITWUI HTALASUTMAQNI,
 AQQ IXHWUI TA'N TELI-TAWAQTWAY.
 O'HAWI-KELU'SIN SE'T A'N, ALASUTWELSEWIK.
 O'HAWI-KELU'SIN SE'T A'N, ALASUTWELSEWIK.

Cmp 388



Cmp 389



Cmp 390



Cmp 394



Cmp 395



Cmp 396



398



399



602

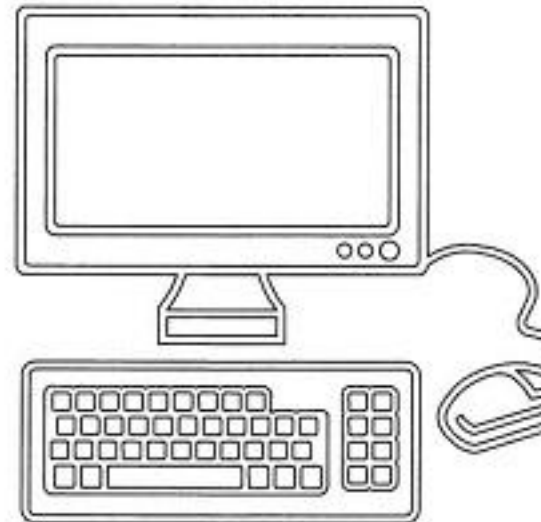

603





608



608 B



612



609



613



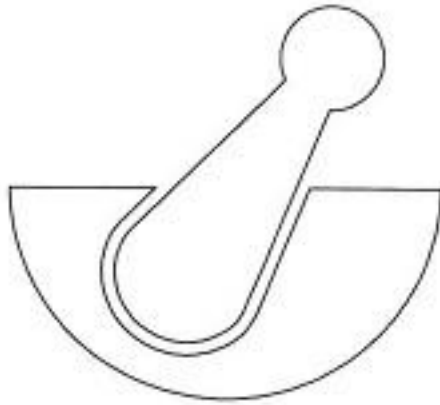

622

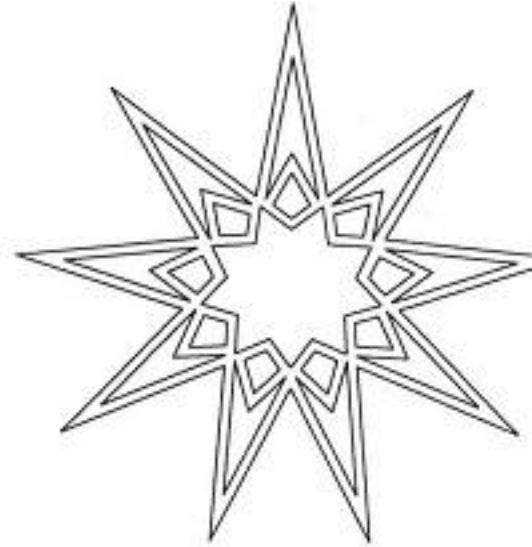

623

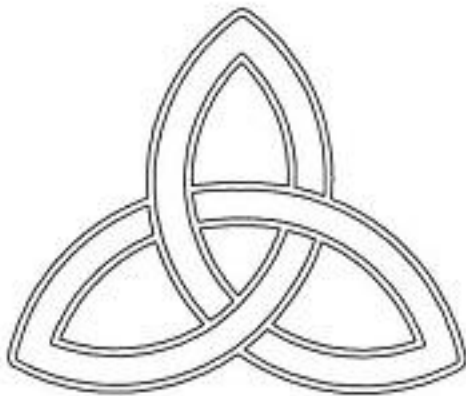

627



627 B



631

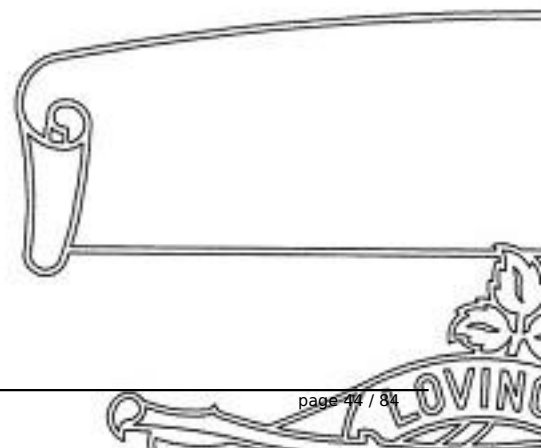



635

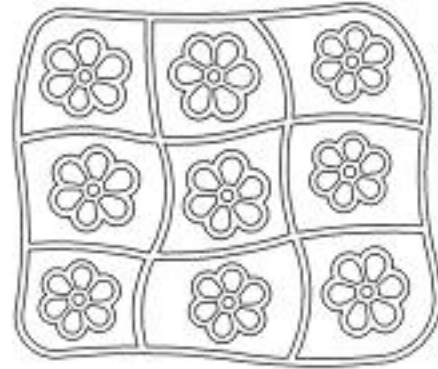

636



639



640



641



644

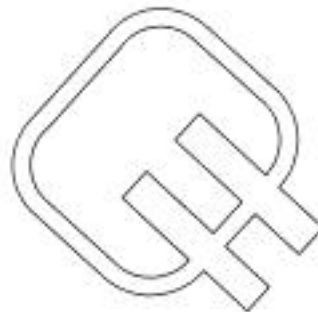

645

Dad

647

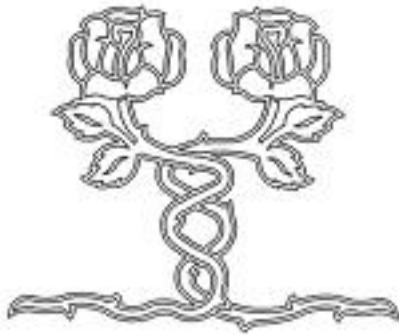

649



650



651



653



654



655

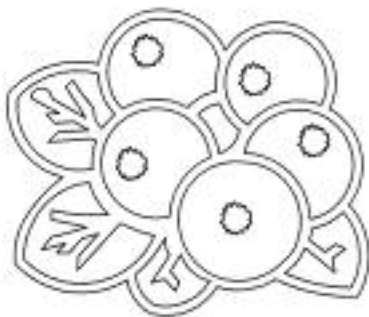

658



659

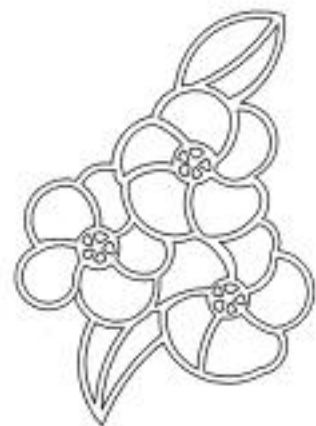

660



663



664



671



669

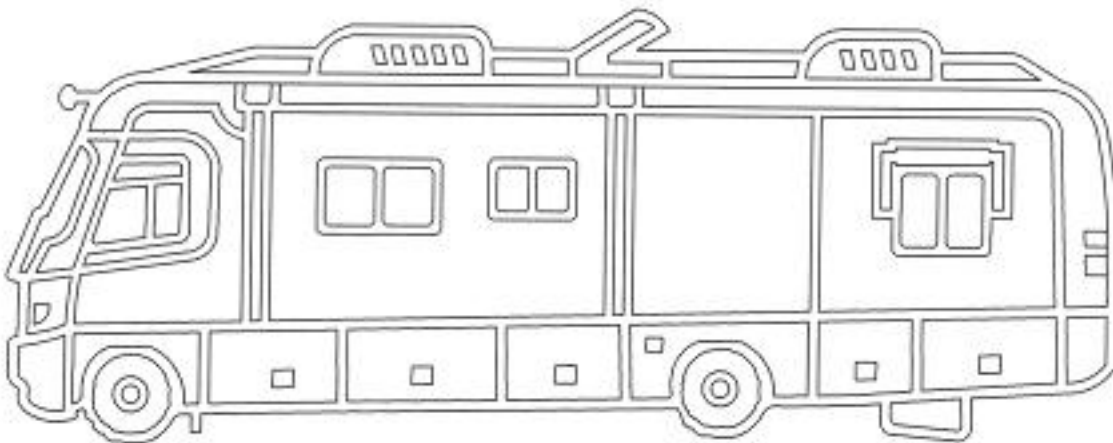

668

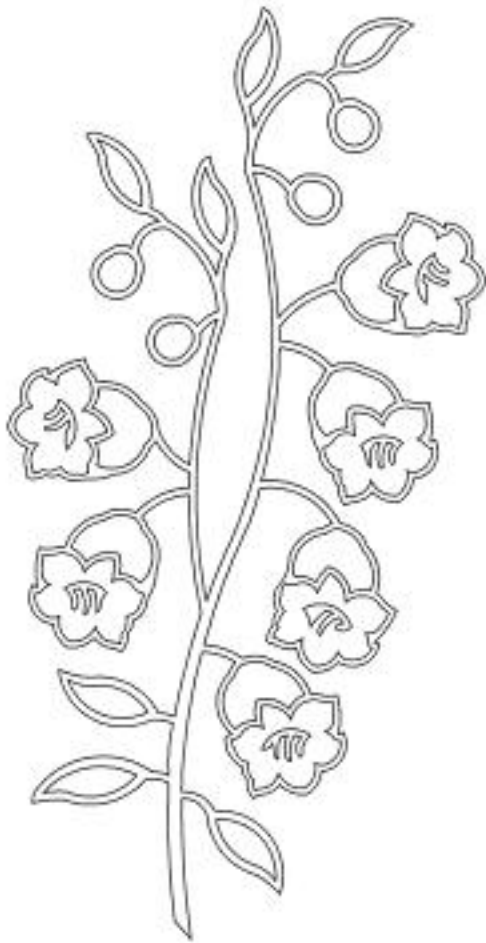

673

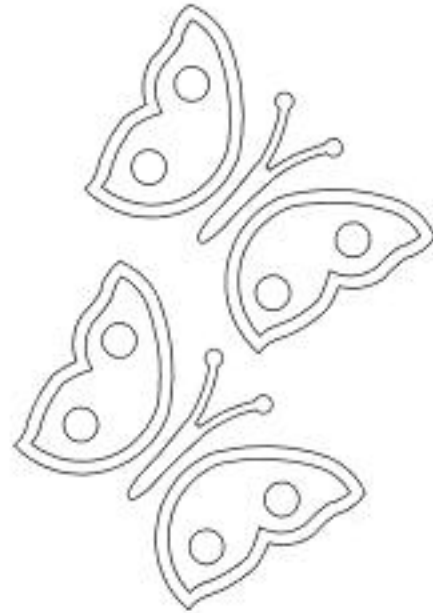

674



675



678

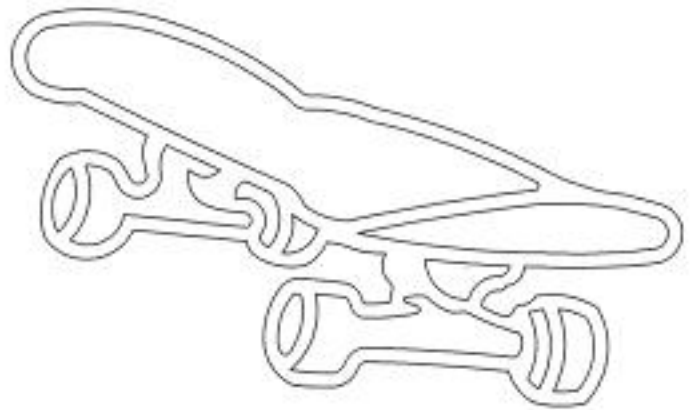

679



686



686B

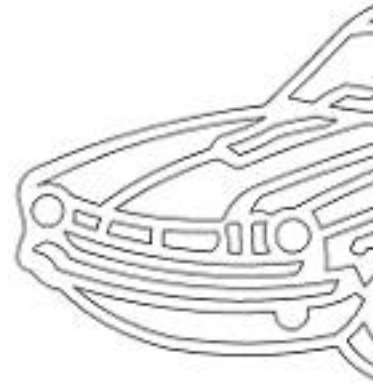

687



683



683B



688

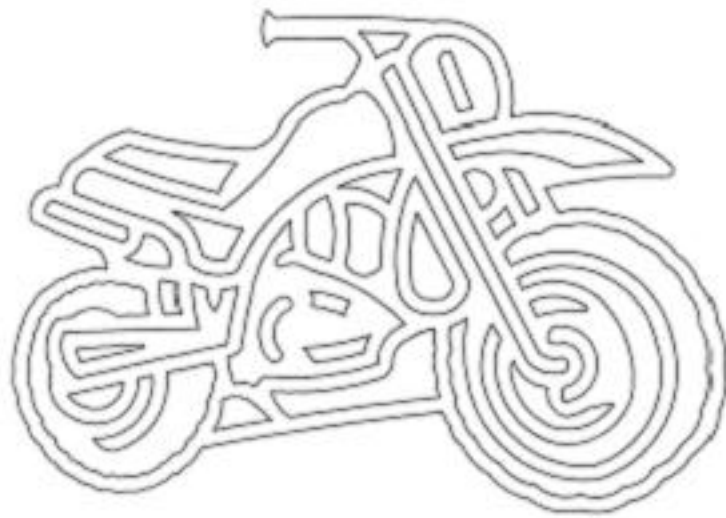

694

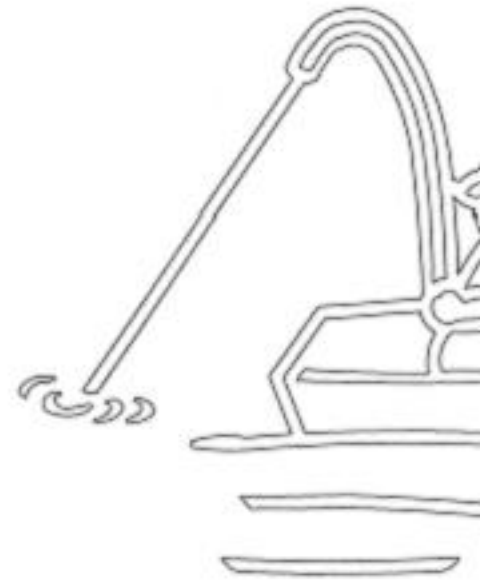

690



691

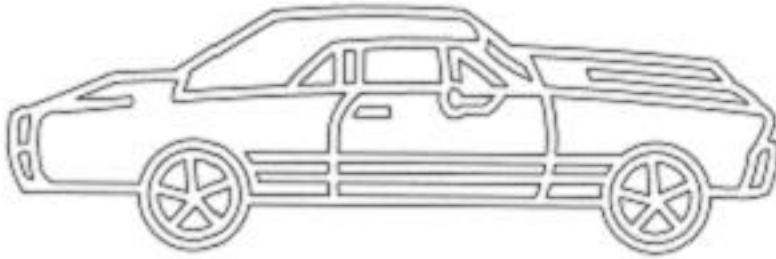

697



698

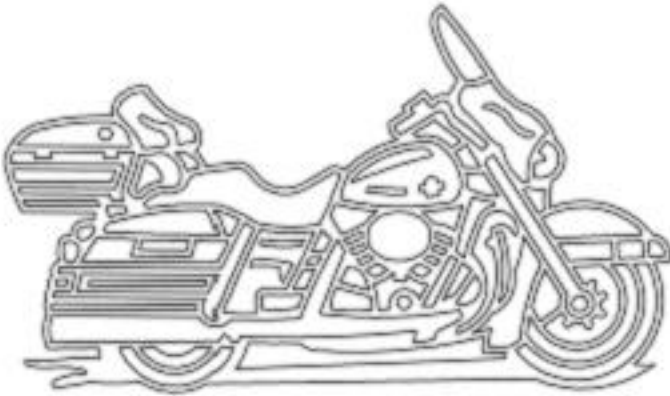

700



701



704



705



708

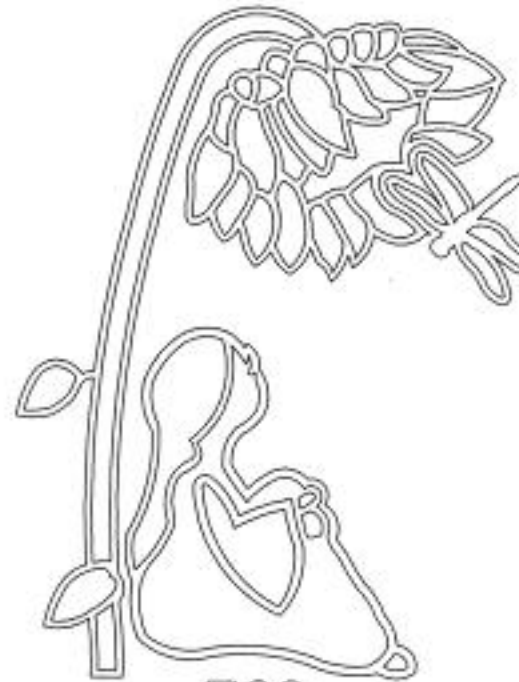

709



712



713

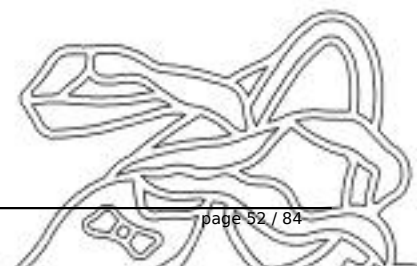
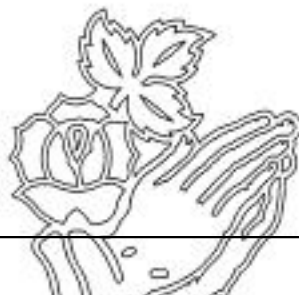



720



721



725



724



726



729

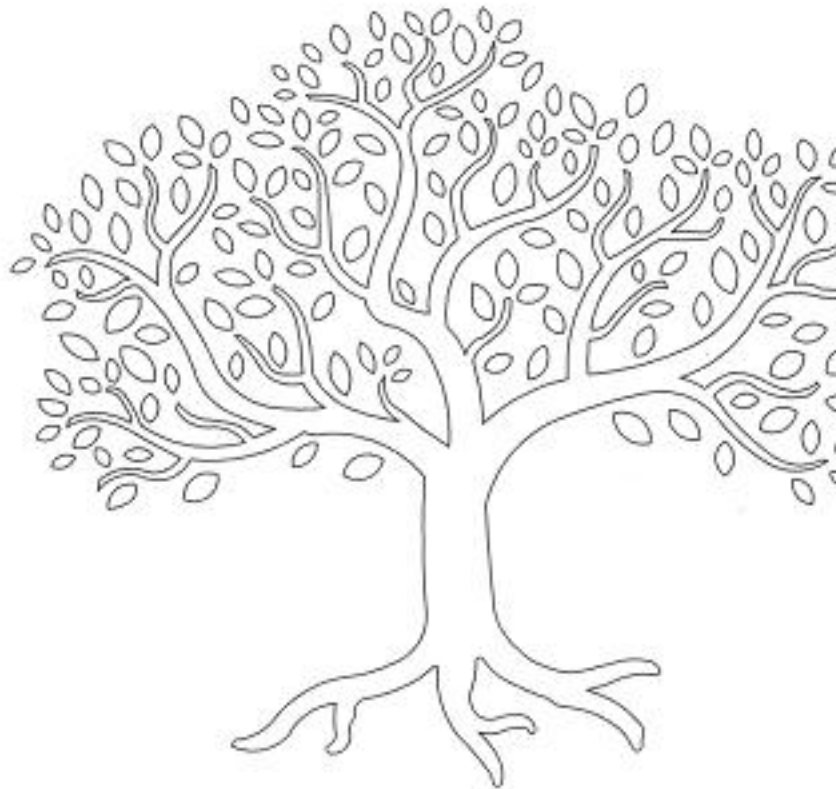

730



733





740



741



744



745

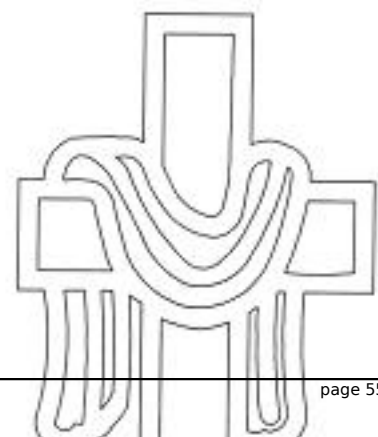

Mom

752

Dad

753

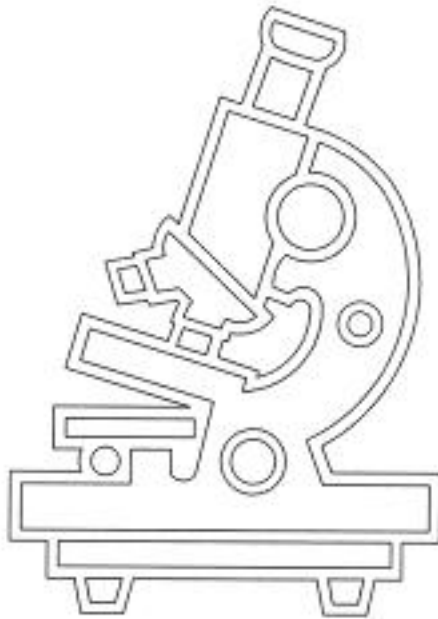

755 B



756

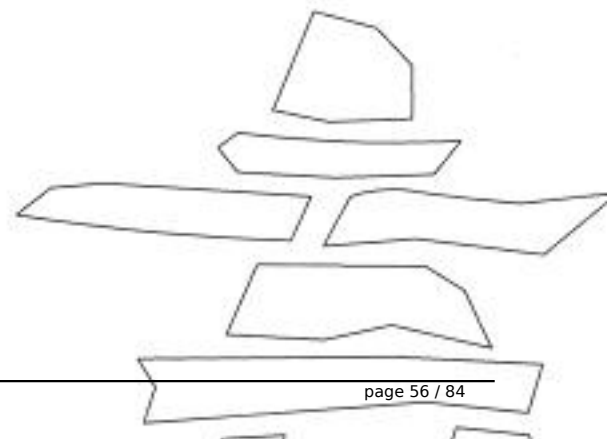
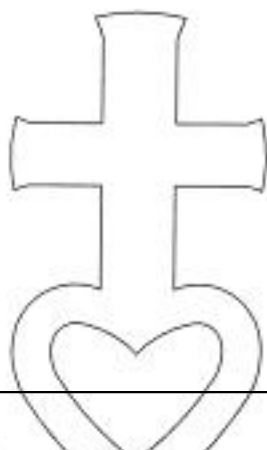



762



763



767,B

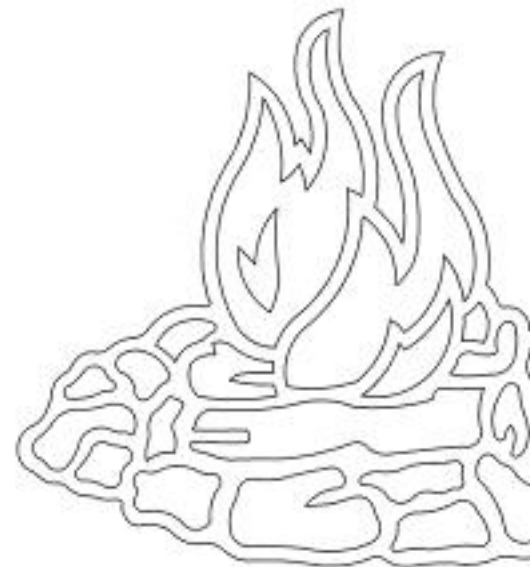

768

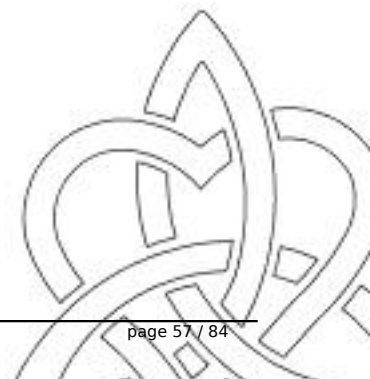



776



777



780



783



791



794B





785



786

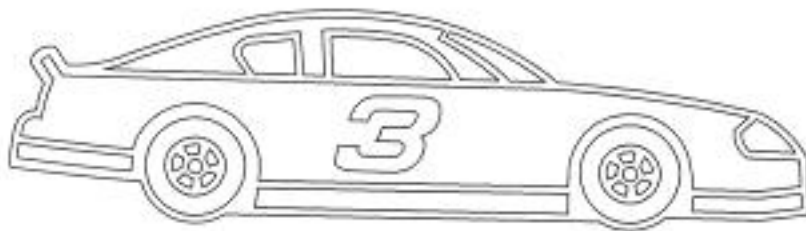

789



790



793



794

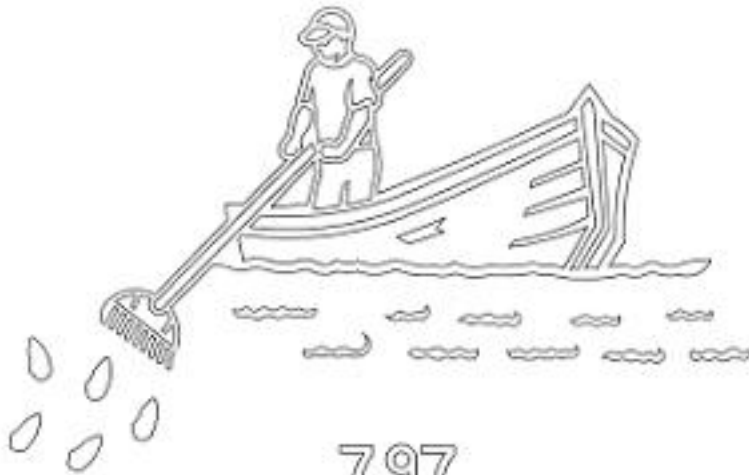

797

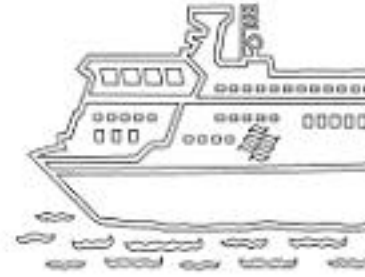

800

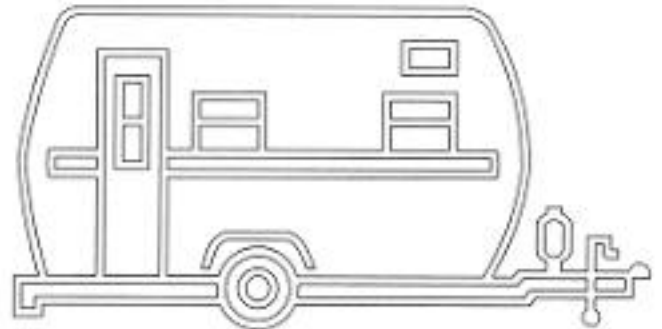

801

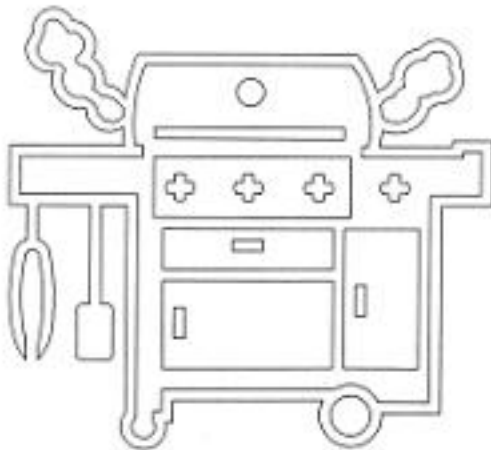

804



805



808

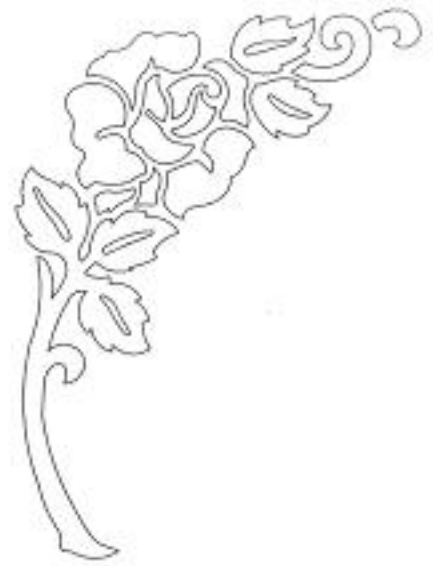

809



812



813

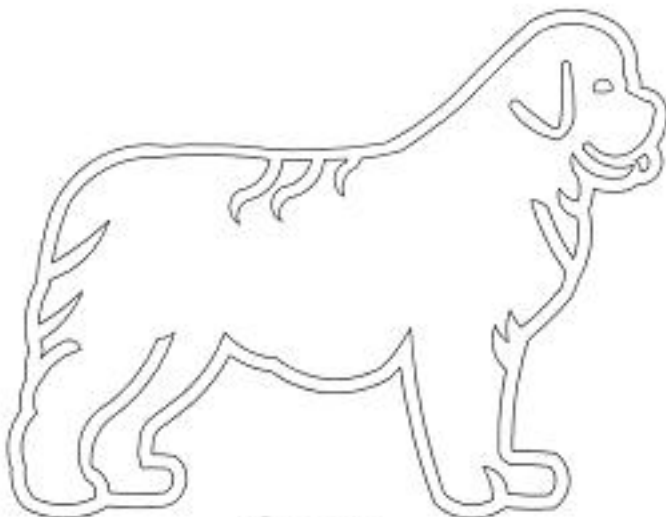

816





820

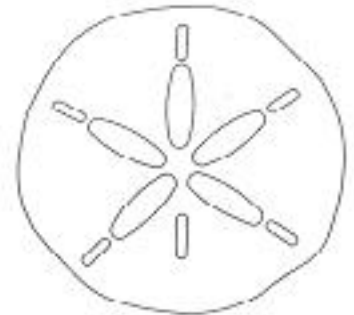

822



825



826



829

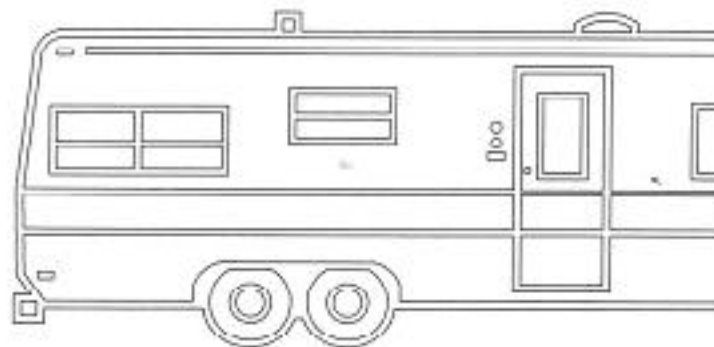

830



832

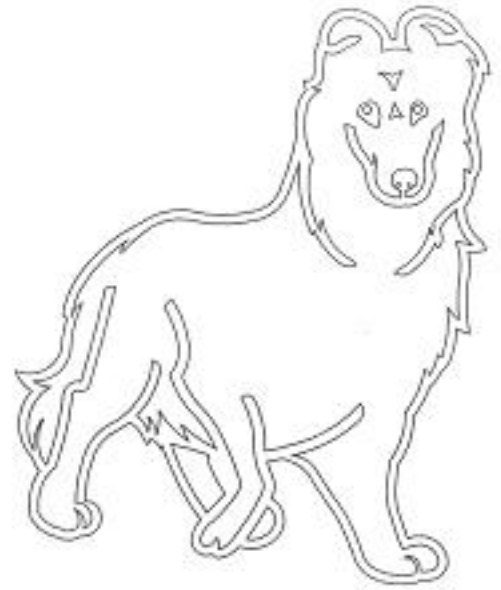

833



836



837

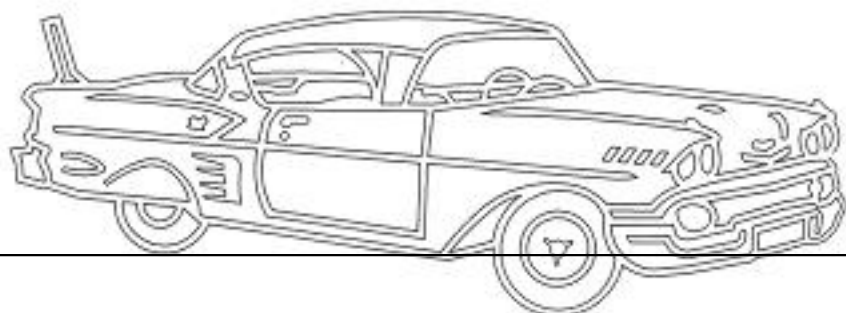

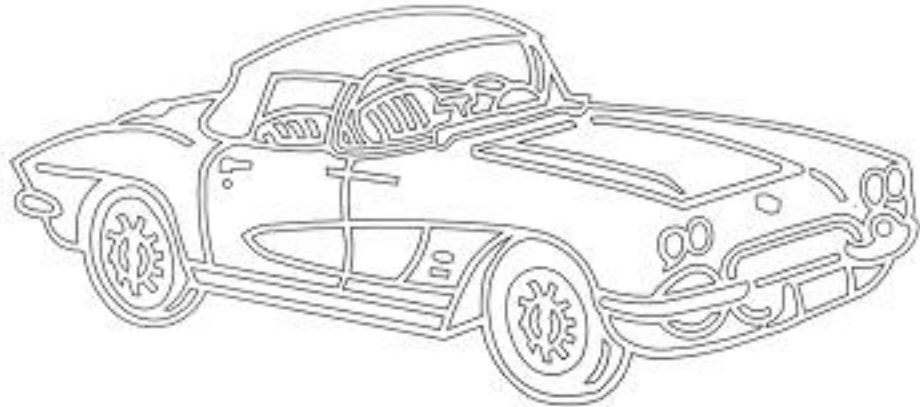

842



845

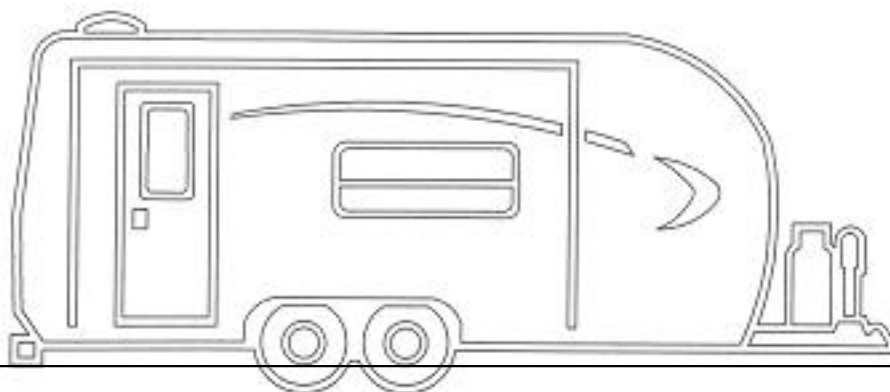



851



852



855

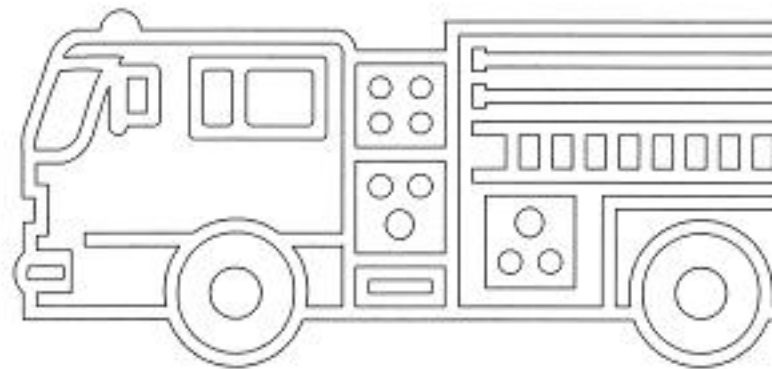

856

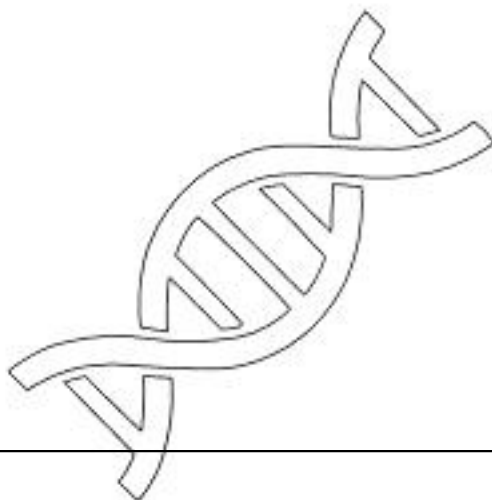

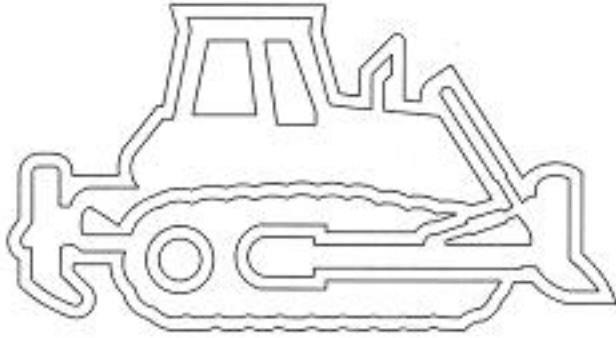

862



863

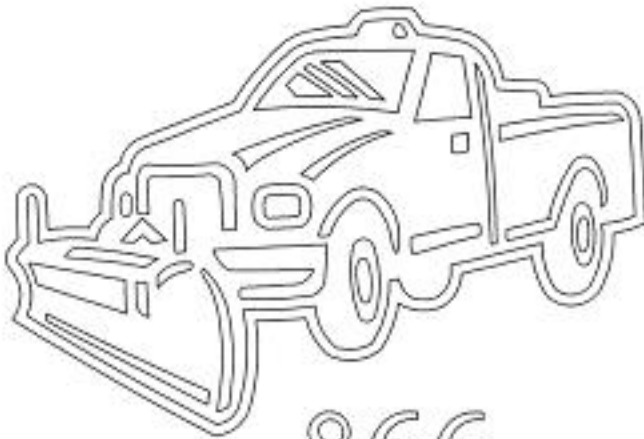

866



867

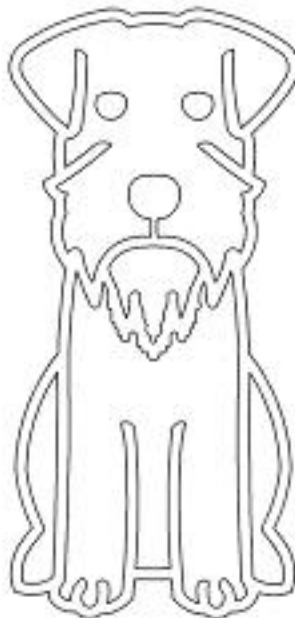

870

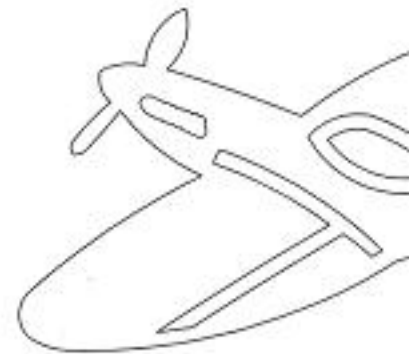

87



873

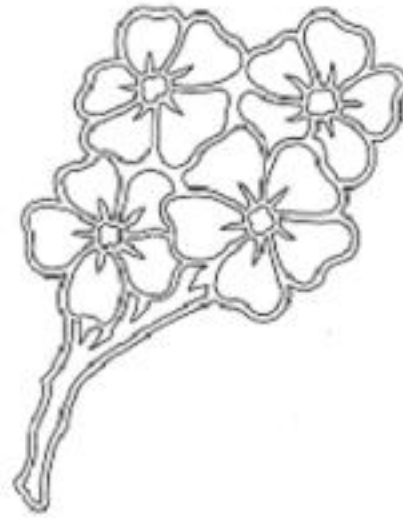

874

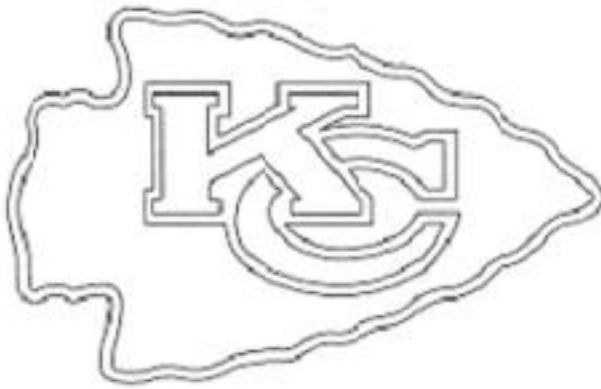

877



878



000



001





884



885



888



889



890



893



894



897

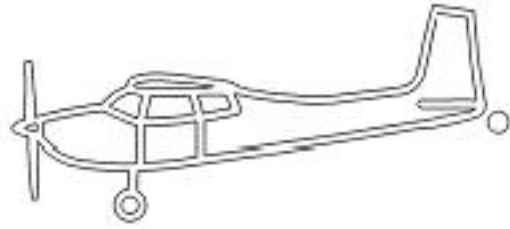

898



8



903



904

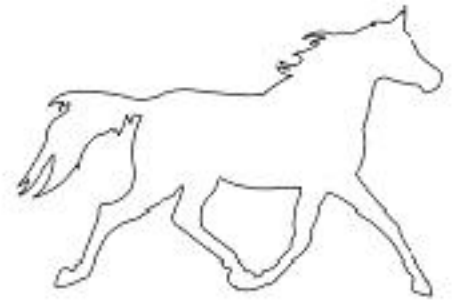

905



907

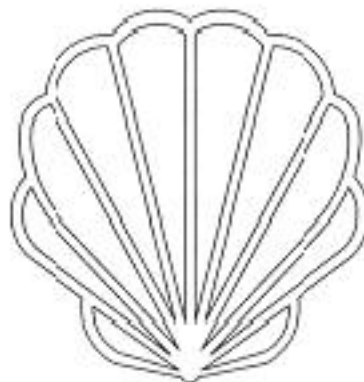

908

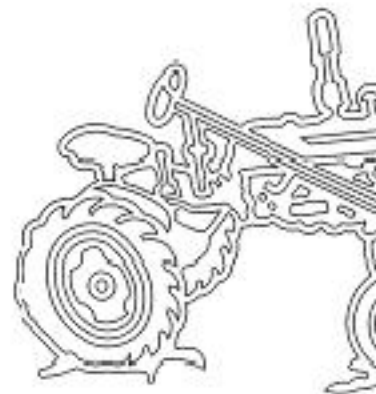

909



912

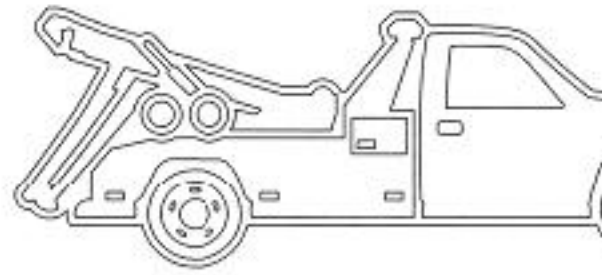

913



916



917



918



921



9

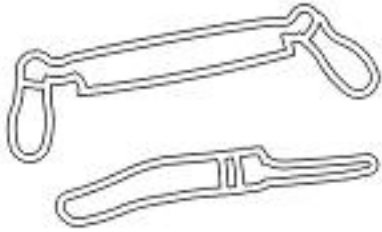

924



925



928

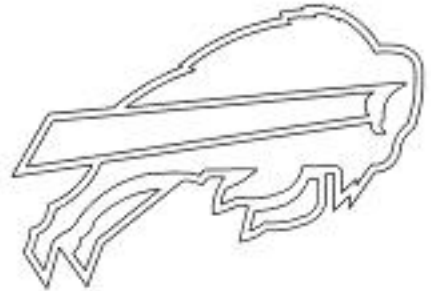

929.B

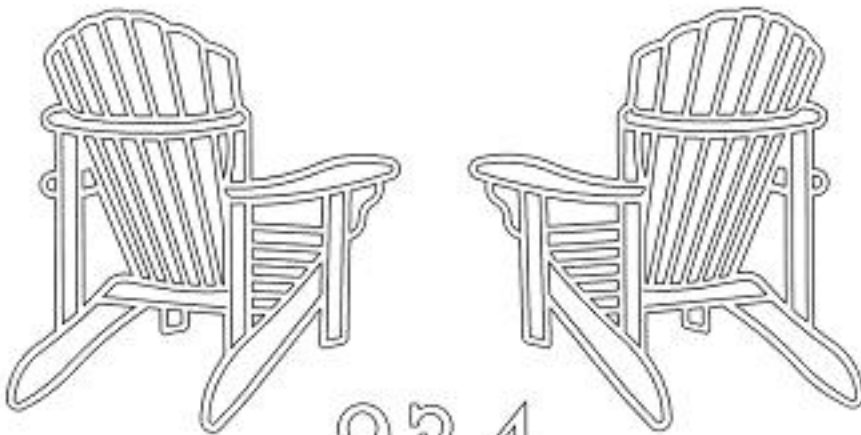

934



935

NUTJIN

NUTJINEN WA'SO'Q EPI
MEKITE'TMEK WA'SO'Q
IKNUMUIEK WLA NEMU'LEK
WA'SO'Q EYKIK TELI SQATA
TELI SQATULEK MA
TELAMU'KTPNI'KI ES
KISKUK TLAMU'KTIJ P
TELIAPIKSIKTAQAJIK WE
KI'L NISKAM TLIAPIKSIK
MLKNIN ME'J WINSUT
KESNUKUAMKI WINJIKL
NATLI

NUTJINEN WA'SO'K EPIN JIPTUK TELUISIN
MEKITE'TMEK WA'SO'K NTLITA'NEN, JIPTUK
IKNMUIEK ULA NEMULEK WLE'TESNEN, NA'TE'L
WA'SO'K EYKIK
TELI-SQATASKIK JIPTUK ELP NINEN
TELI-SQATULEK MAQAMIKEK EYMEK.
TELAMU'K†PNIKL ESMIE'KL APJ NIKE'J
KISKUK TLAMU'KT†J PNEKNMUIN NILU'NAL,
TELI-APIKSIKTAQ†TJIK WEKWAYWINAM†T†PNIK ELP
KI'L NISKAM TLI APIKSIKTUIN. ELUE'WULTIEK,
MLKNIN ME'J WINSUTI'L MUKT IKA'LIN,
KESNUKWAMKL WINJIKL KOQOE'L JIKLA'TUIN.
NATLIAJ.

933

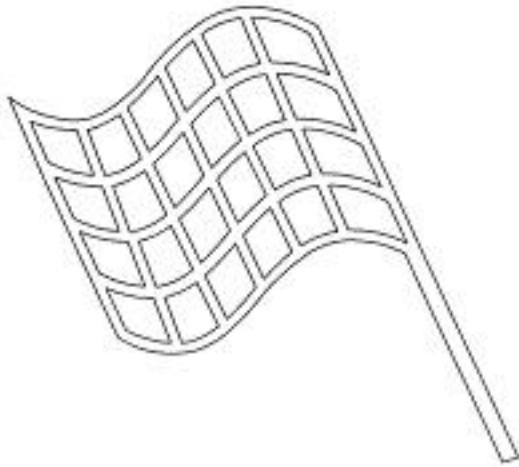

938

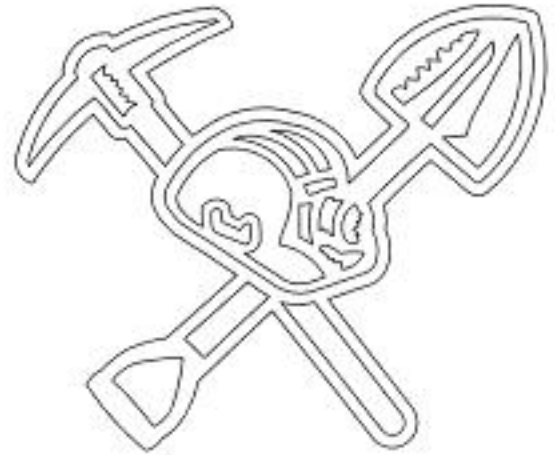

939



941 B

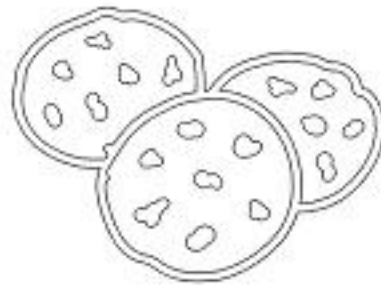

942



943



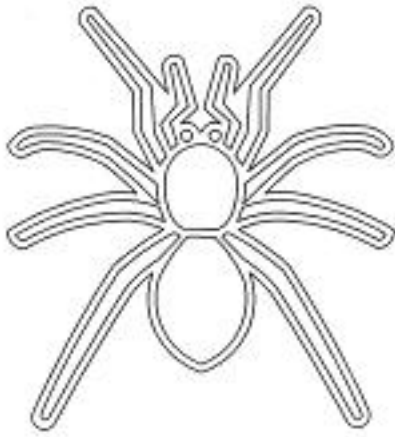

951



952



955

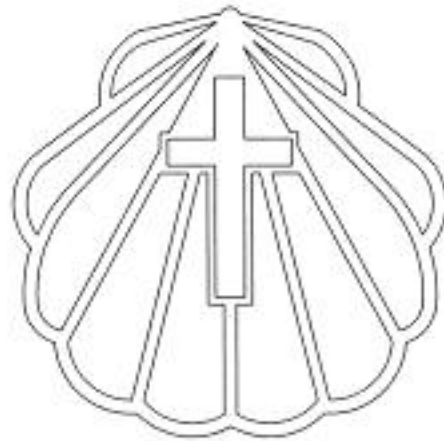

956



960

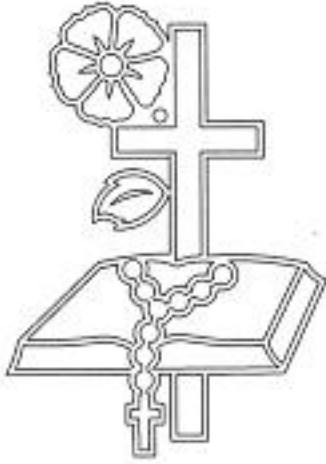

963



964



967



968

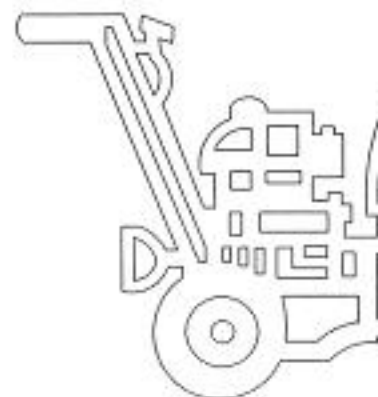



975



976



977



979



980



981



983



984



986B



987



989



990



991



993



994



995



997



998



1001

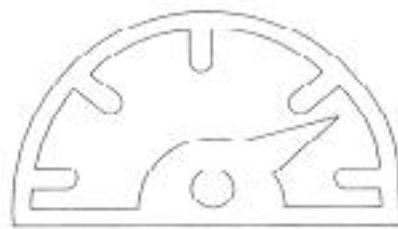

1002



1003



1005



1006

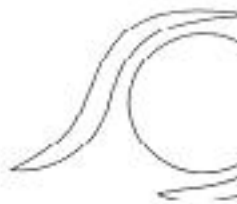

1007



1009



1010



1011



1013



1014



1015



1017



1018



1019

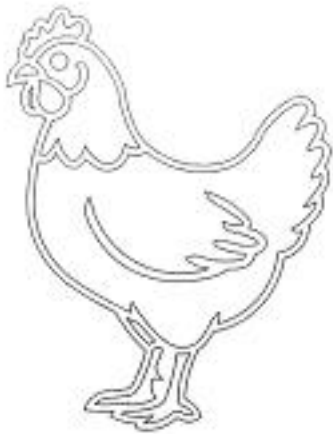

1020B



1021



1022



1024



1025



1023



1027



1028



1029

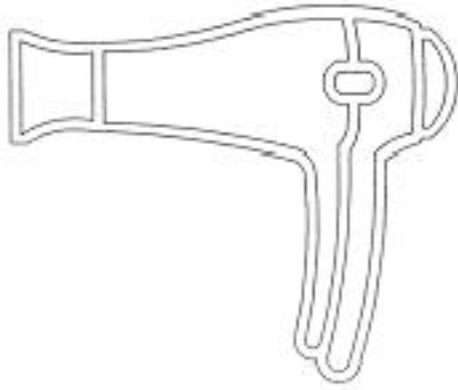

1031



1032

Loving M

1035



1036



1037



1039



1040



1042



1043

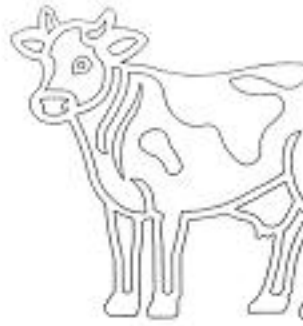

1044



1045



1046



1047



1048